

1. EMBEDDED PARTICULATE / CLEANLINESS PER BR02002-P.
2. FLASH .010 MAX., FIRMLY ATTACHED.
3. GATE + OR - .010 MAXIMUM.
4. SINK IN INSIDE DIAMETER .008 MAXIMUM.
5. MAT'L: TEKNOR APEX 95A0937C-80NT OR EQUIVALENT. VIRGIN W/CERTS.
6. DOUBLE BAG PARTS IN 1.5mm P.E. BAGS
7. INSPECT PER MIL-STD 105D AT 4.0 AQL.
8. PARTS TO BE MANUFACTURED IN CLASS 100,000 CLEAN ROOM ENVIRONMENT.
9. COSMETIC CRITERIA PER BR01020-P, CONNECTOR BODY IS CLASS II-B.

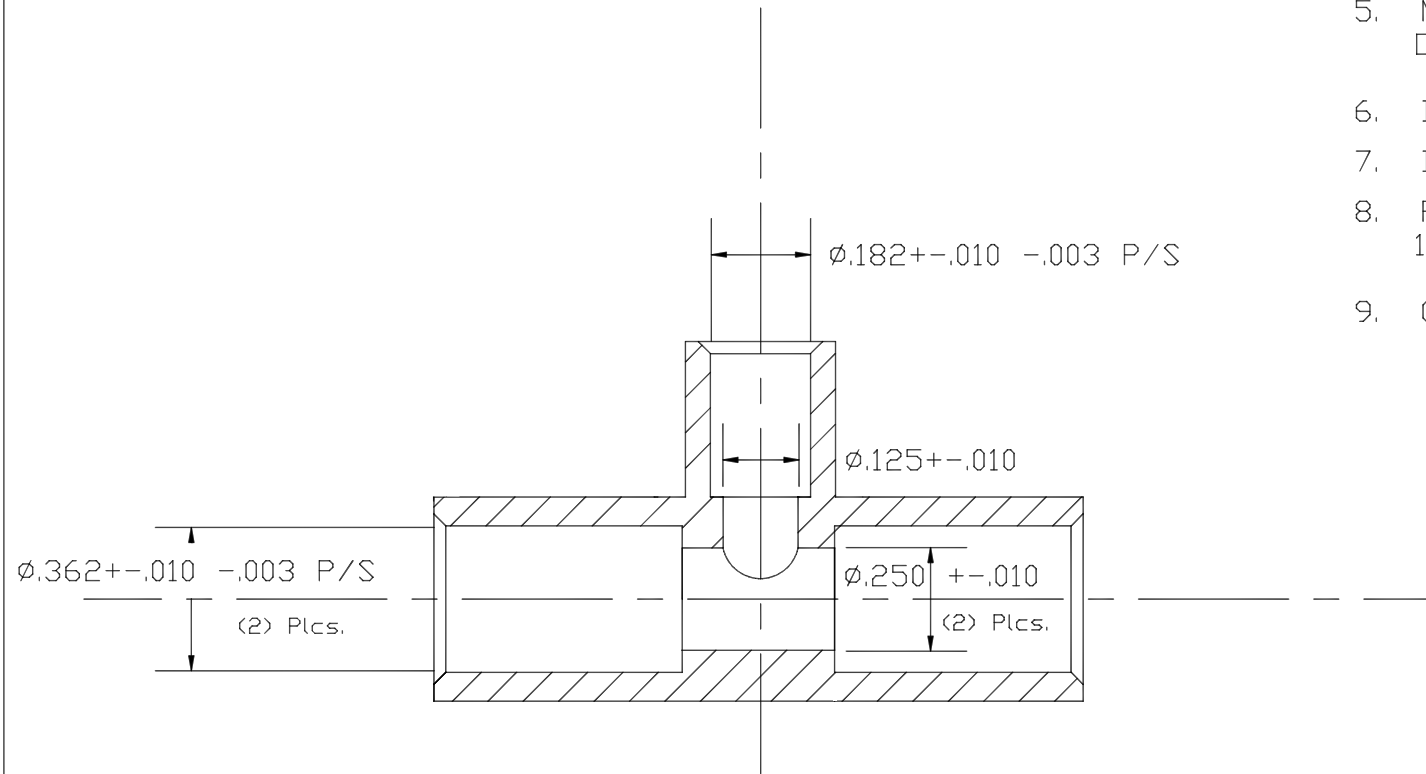

FOR REFERENCE ONLY

SECTION VIEW 2X

NOT TO SCALE

504 "T" CONNECTOR
 1/4 x 1/8 x 1/4
 .062/.032 WALL TUBING

P/N 504-424-N-03

ORDER NO:	DWG NO:	APPROVED:	APPROVED:
T11	504424		

BREVET, INC.